

9"x 8.75" Model K Hinges

Model Number: 2150-K-RH-316

Price: \$ 2530

- Material Type: 316L Stainless Steel
- Maximum Vertical Load: 13,000 LBS
- Maximum Radial Load: 6,820 LBS
- Approx. Width: 8.75"
- Height: 9"
- Leaf Thickness: 1"
- Weight: 61 LBS

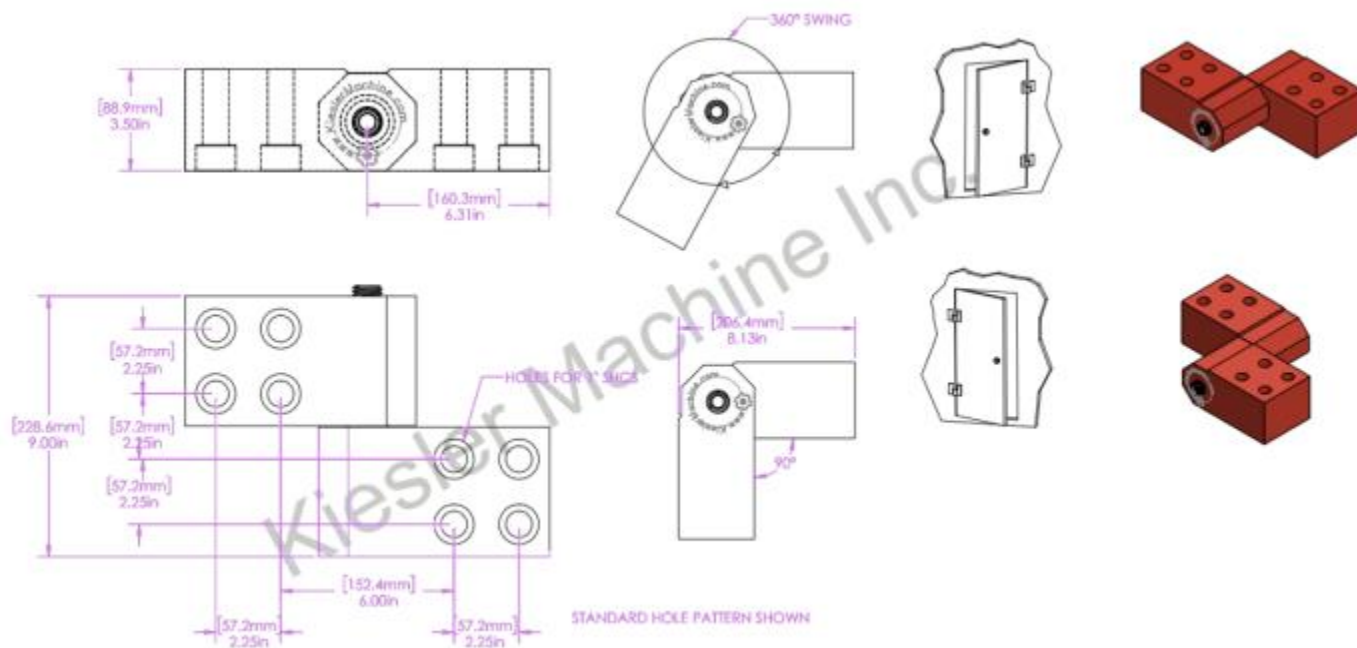

Kiesler Machine Inc

13700 Chrissy Lane NE
Palmyra, IN. 47164-8768

Contact Info :

info@kieslermachine.com
Toll-Free : 888-565-6610
Phone : 812-364-6610



Smoother Than The Rest
Guaranteed!

Data Provided For Reference Only.